

Varenummer: 03555045

Beskrivelse: Fluro hydraulik ledhoved FS 45C

Mål

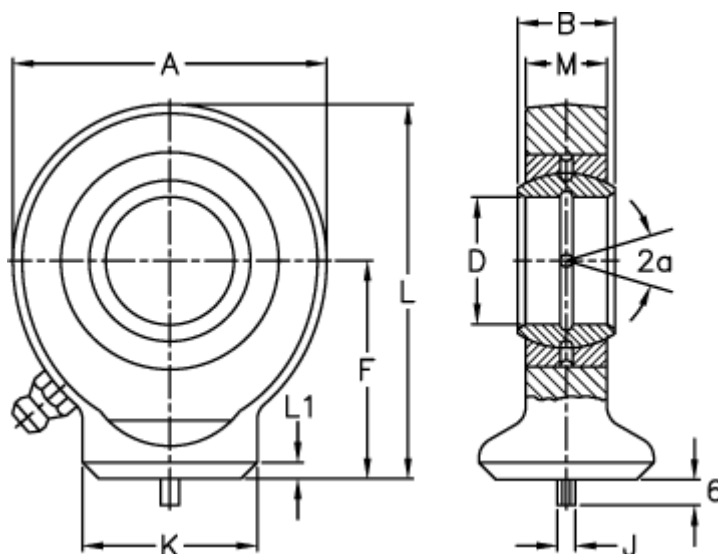

A	= 102	L	= 128
a (grader)	= 7	L1	= 5
B	= 32	M	= 27
D	= 45	Statisk belastning C0 (kN)	= 208
Dynamisk belastning C (kN)	= 127	Vægt	= 1910
F	= 77		
J	= 6		
K	= 58		